



Figure 1. The Photos of Actual AGDT150V2KAS1812

KEY FEATURES

- Fast Response Time for Reliable Protection
- Stable and Dependable Operation without Aging
- High Current Capability for Variety of Applications
- Low Capacitance and High Insulation Resistance to Minimize Burden to the Signal
- RoHS & REACH Compliant

APPLICATIONS

- Broadband Devices
- CATV and Satellite Equipment
- MDF (Main Distribution Frame) Module
- Base Station and Antenna
- XDSL (X Digital Subscriber Line) Modems
- Power Supply and RF Systems
- Consumer Electronics
- N-PE (Neutral and Protective Earth) Mode Protection in AC Power Systems

DESCRIPTION



A gas discharge tube (GDT) is a type of protective device consisting of metal electrodes and metallized ceramics enclosed in a sealed space. It is filled with a discharge medium, such as an inert gas or gas mixture, at varying atmospheric pressures to create a single-gap or multi-

gap switch. GDTs are designed to protect electronic equipment and systems from voltage surges or transients by providing a low-impedance discharge path. GDTs have a high insulation resistance, low capacitance, and minimal leakage, ensuring that they have little to no impact on the normal operation of equipment. They are widely used in surge protectors, lightning arrestors, telecommunications systems, power distribution, automotive electronics, medical devices, industrial controls, and aerospace and defense applications.

Using AGDT150V2KAS1812

1. To ensure safe operation, do not use a gas discharge tube (GDT) in power supply networks where the maximum voltage exceeds the minimum spark-over voltage of the GDT.
2. Prolonged current stress may cause the GDT to become hot and pose a burn risk. Overload may cause the connectors to fail or the component to be destroyed.
3. Defective contacts on surge arresters can lead to sparks and loud noises under current load.
4. The GDT is designed to operate in a range of air pressure between 55kPa to 106kPa, which corresponds to an altitude of +5000m to -500m, respectively.
5. The packaged GDT should be stored in a dry, ventilated, and non-corrosive environment to ensure optimal performance.
6. To avoid electrical shock, do not install the GDT in a location where it can be touched by humans.
7. When assembling, avoid violent actions such as knocking that may cause product failure.

AGENCY APPROVALS

Agency	Standard	File Number
	UL497B	E513446
	TUV	In Process



NAMING PRINCIPLE

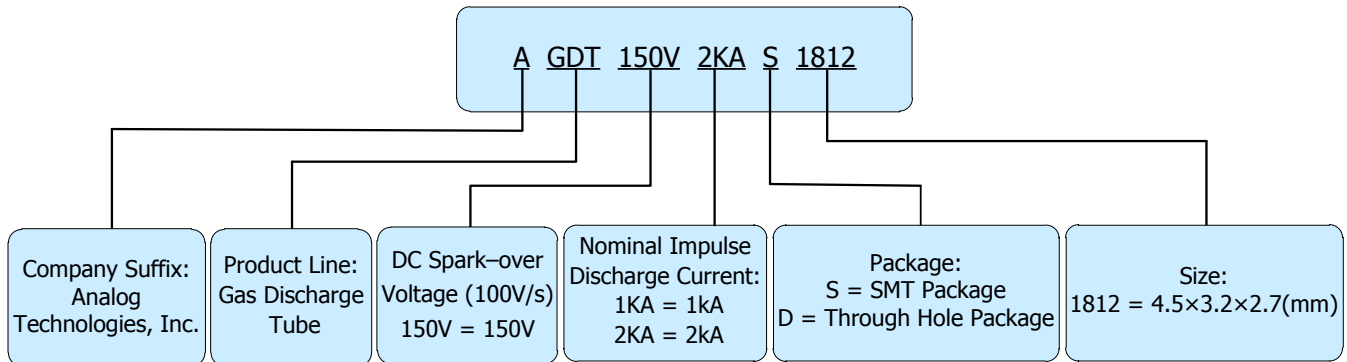

Naming Principle of AGDT150V2KAS1812

SPECIFICATIONS

Table 1. Specifications for AGDT150V2KAS1812 Families

Part Number	DC Spark-over Voltage			Impulse Spark-over Voltage	Arc Voltage	AC Discharge Current	Insulation Resistance		Capacitance	Max Impulse Discharge Current
	@100V/ μ s			@1000V/ μ s	@1A	@50Hz, 1s	V _{DC}	IR	0.5VDC @1MHz	@8/20 μ s
	V			V	V	A	V	G Ω	pF	kA
	Min	Typ	Max	Max	Typ	-	-	Min	Max	Max
AGDT90V1KAS1812	72	90	108	600	8	1	50	1	0.6	1
AGDT150V1KAS1812	120	150	180	600	8	1	50	1	0.6	1
AGDT200V1KAS1812	160	200	240	700	10	1	100	1	0.6	1
AGDT230V1KAS1812	184	230	280	700	10	1	100	1	0.6	1
AGDT300V1KAS1812	240	300	360	800	10	1	100	1	0.6	1
AGDT350V1KAS1812	280	350	420	1000	10	1	100	1	0.6	1
AGDT400V1KAS1812	320	400	480	1000	12	1	100	1	0.6	1
AGDT420V1KAS1812	336	420	504	1000	12	1	100	1	0.6	1
AGDT470V1KAS1812	376	470	564	1200	12	1	100	1	0.6	1
AGDT600V1KAS1812	480	600	720	1400	15	1	100	1	0.6	1
AGDT90V2KAS1812	72	90	108	600	8	2	50	1	0.6	2
AGDT150V2KAS1812	120	150	180	600	8	2	50	1	0.6	2
AGDT200V2KAS1812	160	200	240	700	10	2	100	1	0.6	2
AGDT230V2KAS1812	184	230	280	700	10	2	100	1	0.6	2
AGDT300V2KAS1812	240	300	360	800	10	2	100	1	0.6	2
AGDT350V2KAS1812	280	350	420	1000	10	2	100	1	0.6	2
AGDT400V2KAS1812	320	400	480	1000	12	2	100	1	0.6	2
AGDT420V2KAS1812	336	420	504	1000	12	2	100	1	0.6	2
AGDT470V2KAS1812	376	470	564	1200	12	2	100	1	0.6	2
AGDT600V2KAS1812	480	600	720	1400	15	2	100	1	0.6	2



ELECTRICAL CHARACTERISTIC

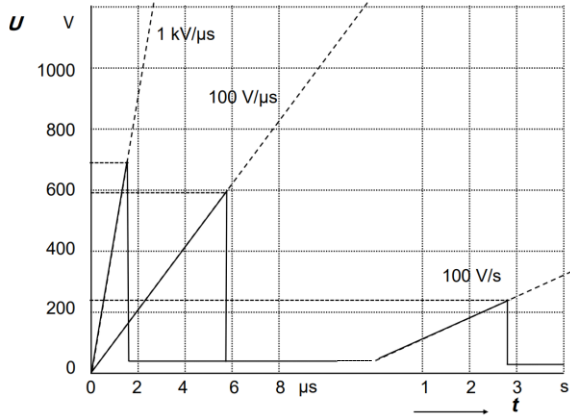

Figure 2. Spark-over Voltage Waveform

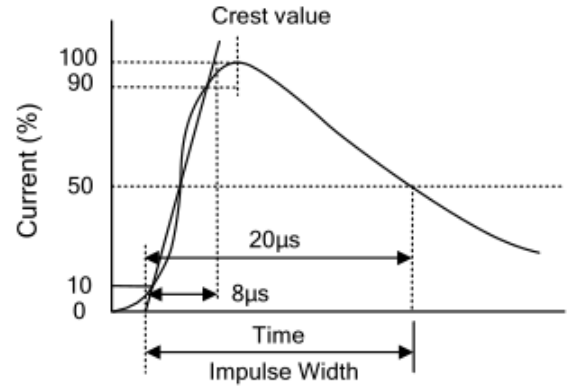
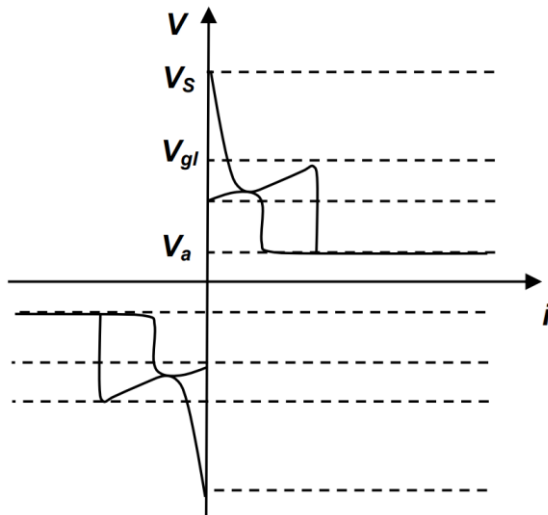

Figure 3. Impulse Discharge Current Waveform



V_s : Spark - over Voltage
 V_{gl} : Glow Voltage
 V_a : Arc Voltage
 G : Glow Mode
 A : Arc Mode

Figure 4. Voltage vs. Current characteristics

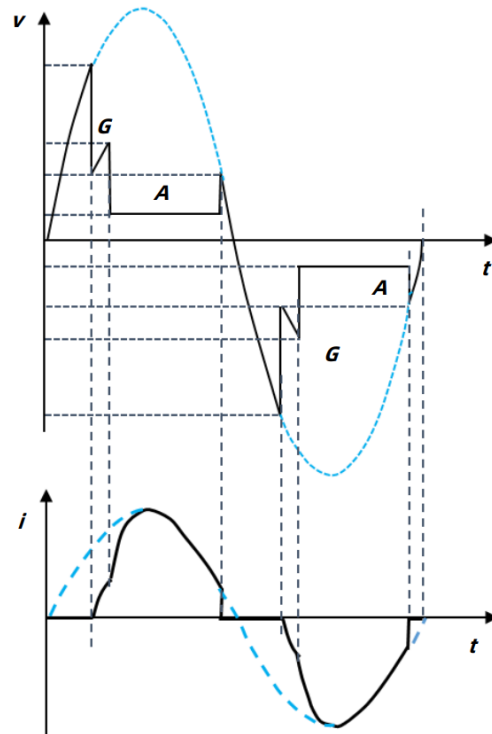

Figure 5. Voltage and Current Waveforms



APPLICATION CIRCUITS

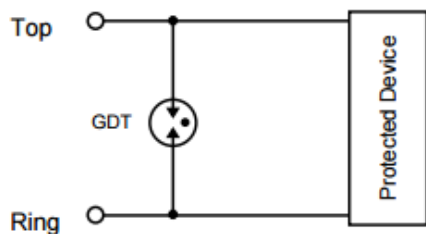

Figure 6. Signal Input Protection Circuit

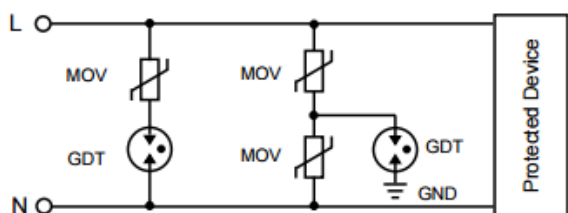
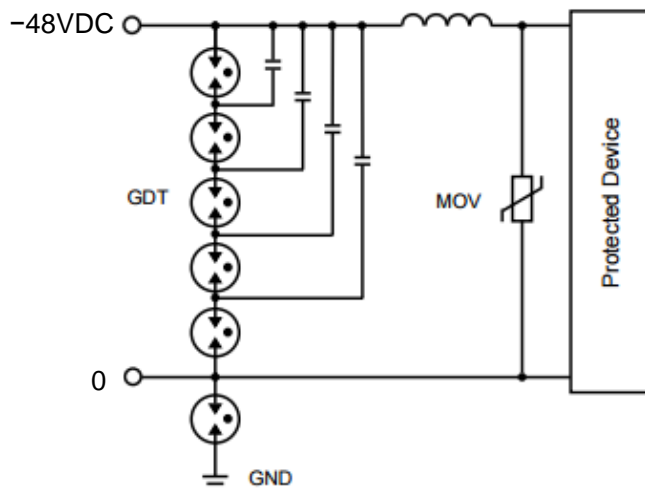

Figure 7. AC Power Input Protection Circuit



NOTE: MOV means Varistor

Figure 8. Power Supply Input Protection Circuit

RECOMANDED SOLDERING Profile and CONDITIONS

During the soldering process, it is important to ensure that the GDT is not subjected to excessive thermal stress or mechanical stress, which can also damage the GDT. Care should be taken to avoid overheating the GDT and to avoid applying excessive force or pressure during the soldering process. It can be soldered by reflow oven or hand soldering.

Reflow Soldering

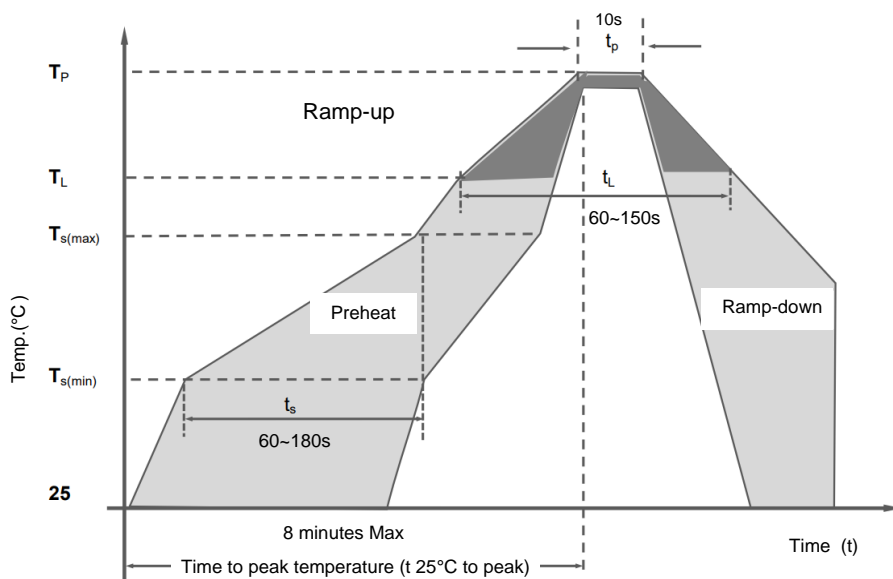

Figure 9. Reflow Soldering



Reflow Condition		Pb-Free Assembly
Pre Heat	Temp. Min $T_{s(min)}$	150°C
	Temp. Max $T_{s(max)}$	200°C
	Time (Min to Max) t_s	(60 ~ 180)s
Average ramp up rate (Liquidus Temp (T_L) to peak)		3°C/second max
$T_{s(max)}$ to T_L Ramp-up Rate		5°C/second max
Reflow	Temperature (T_L) (Liquidus)	217°C
	Temperature (t_L)	(60 ~ 150)s
Peak Temperature (T_P)		(255 ~ 260)°C
Time within 5°C of actual peak Temperature (t_P)		≈ 10s
Ramp-down Rate		6°C/second max
Time 25°C to peak Temperature (T_P)		8 minutes max
Do not exceed		260°C

Hand Solder Parameters

Items	Condition
Iron Temperature	350°C
Soldering Time	4s (Max.)
Space between Soldering Point and the Bottom of Product	2mm (Min.)

PACKAGING INFORMATION

This GDT is packaged in reels: up to 2500/reel; inner boxes: 2 reels/inner box; and carton outer box: 8 inner box/carton box.

Item	Reel	Inner	Carton
Dimensions (mm)	Φ330 × 12.8	340 × 340 × 40	360 × 360 × 360
Quantity (Pcs)	2500	5000	40000
Note: The dimensions and quantity of packaging are for reference only.			

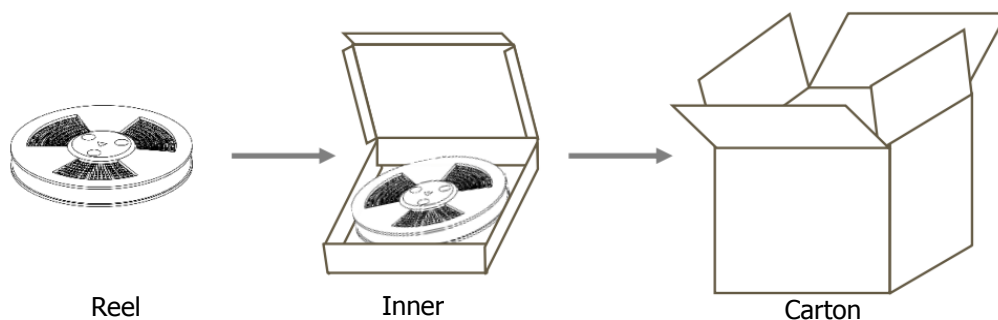



DIMENSIONS

Outline Dimensions

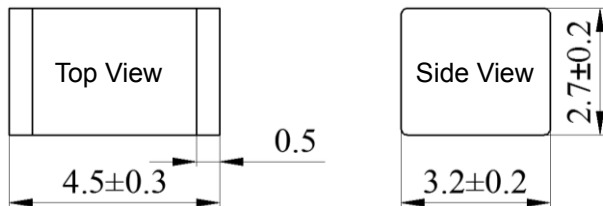

Unit: mm

Figure 10. Outline Dimensions

Recommended Pad Size

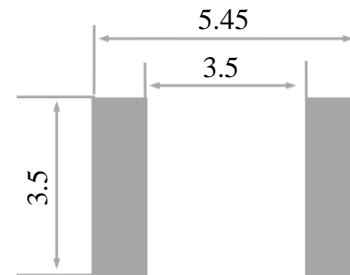

Unit: mm

Figure 11. Recommended PCB Pad Size

NOTICE

1. ATI warrants its products to perform according to specifications for one year from the date of sale, except when damaged due to excessive abuse. If a product fails to meet specifications within one year of the sale, it can be exchanged free of charge.
2. ATI reserves the right to make changes or discontinue products or services without notice. Customers are advised to obtain the latest information before placing orders.
3. All products are sold subject to terms and conditions of sale, including those pertaining to warranty, patent infringement, and limitation of liability. Customers are responsible for their applications using ATI products, and ATI assumes no liability for applications assistance or customer product design.
4. ATI does not grant any license, either express or implied, under any patent right, copyright, mask work right, or other intellectual property right of ATI.
5. ATI's publication of information regarding third-party products or services does not constitute approval, warranty, or endorsement.
6. ATI retains ownership of all rights for special technologies, techniques, and designs for its products and projects, as well as any modifications, improvements, and inventions made by ATI.